

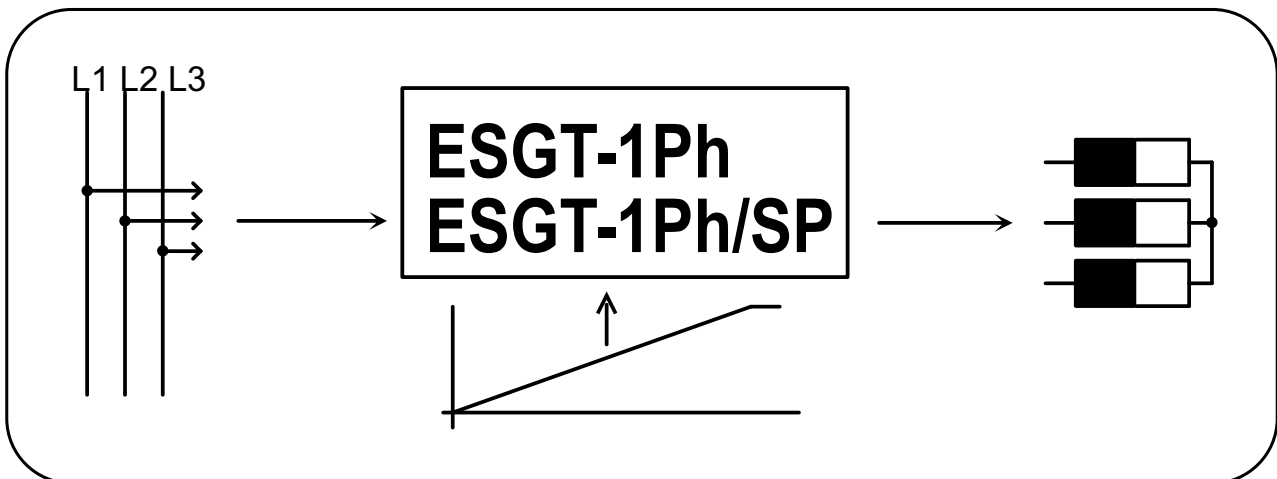

## Start-up instructions

### Thyristor controller Type: **ESGT-1Ph, ESGT-1Ph/SP** Three phase controller W3C



## Contet

|  | Page |
|--|------|
| 1. Important safety instructions.....                                  | 2    |
| 2. General instructions.....   | 2    |
| 3. Technical explanations on thyristor controllers.....                | 3    |
| 4. Installation of the thyristor controller ESGT-1Ph, ESGT-1Ph/SP..... | 4    |
| 5. EMC-equitable assembly.....   | 4    |
| 6. Operation.....  | 6    |
| 7. Meaning of the clamp connections.....                               | 7    |
| 8. Technical features of the control and monitoring panel.....         | 8    |
| 9. Basic circuit.....  | 9    |
| 10. Control and monitoring print.....                                  | 10   |
| 11. Control unit.....  | 11   |
| 11.1 Analogous module.....   | 11   |
| 11.2 Settings for the varicos controls.....                            | 12   |
| 12. Survey of the individual types.....                                | 13   |
| 13. Technical data.....  | 14   |
| 14. Frame sizes.....   | 15   |

## 1. Important safety instructions

This manual contains instructions, which have to be observed for your personal safety and for the prevention of material damage. The instructions about your personal safety are highlighted with a warning triangle labelled with three exclamation marks, hints about material damages are listed with a warning triangle and one exclamation mark.



### **Danger-symbol**

Personal injury **may** occur, if appropriate safety precautions are not taken.



### **Caution-symbol**

Material damages may occur, if appropriate safety precautions are not taken into account.



### **Disposal regulations**

The devices contain electrical components and must not be disposed together with household garbage. The devices for disposal have to be recycled according to local and currently valid regulations for electronic waste.

### **Qualified personnel**

The corresponding device/system may only be set up and operated in conjunction with this documentation. Commissioning and operation of the device/system may only be performed by **qualified personnel**. Qualified personnel within the meaning of the safety instructions in this documentation are persons with the authority to put electric circuits into operation, provide ground connections and label them according to current safety regulations.

The device should only be used in applications described in this document. The reliable and proper use of the product depends on appropriate transport, storage, installation and careful commissioning.

## 2. General instructions

### **Use of the document**

This instruction should demonstrate the technical application possibilities of the thyristor controller to the engineer in charge.

### **Target group**

The document should assist the user during commissioning. It also helps in case of service and maintenance work. It supports the planner and project engineer with the conception of new plants.

### **Necessary competence**

Generic skills in the field of electrical engineering are necessary.

### **Validity**

The present document is valid for the thyristor controller of the type ESGT-1Ph... . It contains the currently valid description of the unit. We reserve the right to attach new descriptions of the devices. This involves types and options with modified version status of the technical documents.

### **Standards and approvals**

The thyristor controller of the type ESGT-1Ph... are based on the IEC/EN 60947-4-3 standard.

**Disclaimer**

It lies within the responsibility of the plant manufacturer of the technical equipment or machine to ensure the proper overall function. The producer can not guarantee all properties of the overall system or the machine.

**3. Technical explanations on thyristor controllers**

The thyristor controller is more and more used in sectors, in which bigger loads of ohm and inductive loads have to be regulated (i.e.: building of industrial furnaces, plastics processing, etc.).

Due to its modular, compact construction and its controlling by a continual control signal, these wattage regulators become a perfect device for industrial control of wattage input. The power element of the thyristor controller consists of six antiparallel connected thyristors, the isolated cooling system and the electronic regulation and watching.

**Type description:**

|                       |   |
|-----------------------|---|
| <b>ESGT-3Ph...</b>    | three phase current controller<br>(based on the phase operating principle, phase angle control) |
| <b>ESGT-1Ph...</b>    | single phase regulator for AC current loads<br>(based on the phase operating principle)         |
| <b>ESGT-3Ph/SP...</b> | three phase current controller (multicycle control)   |
| <b>ESGT-1Ph/SP...</b> | single phase regulator for AC current loads (multicycle control)                                |

Thyristor controllers for phase angle control (ESGT-3Ph... and ESGT-1Ph...) serve to control ohmic and inductive loads. The activation is standardly made via proportional signals (0...10V, 0...20mA or 4...20mA). The phase angle or the on and off clock ratio with multicycle control is constantly adjusted by the control electronics, to achieve a sufficient proportionality between the activation and the output (T1, T2) of the thyristor controller. Aside from the device series already mentioned, we have single and three phase versions, which cover the lower current range up to 12A. These devices are also available in snap-on design.

**Current limiting:**

At firing mode the current load can be regulated by a potentiometer between 1 and 100%. As a matter of fact the actual value of the current load is limited.

**Voltage supply:**

Different values of mains voltage are balanced so that any voltage variability of the load is avoided.

**Construction:**

The thyristor controller agrees with VDE 0558 part 1 and VDE 0160 table 4.

The thyristor controller ESGT-1Ph... is assembled modularly. It consists of three basic elements:

- power element with cooling system and thyristor switching facility
- control unit with electronic starting and control system (diagnostic indicator, regulation port etc.)
- function module which determines the analogous regulation

## 4. Installation of the thyristor controller ESGT-1Ph, ESGT-1Ph/SP

The built-in device, according to IP 23 has to be mounted in a housing or a switchboard panel. Take care of adequate cooling (separate ventilation, for instance). The environment temperature must not exceed the value of 55°C. The device is to be mounted on a vertical plane, avoiding that the ventilating pipes of the cooling element are not placed vertical. The device has to be mounted in a dry room.

Further conditions to the operating area:



- protection from dust and moisture
- protection from aggressive atmosphere
- free from vibrations

No other devices should be placed closer than 50 to 100mm to the device, in order to provide adequate cooling.

The housing equipment according to IP 54 can be placed in locations Which are not protected from dust and moisture.

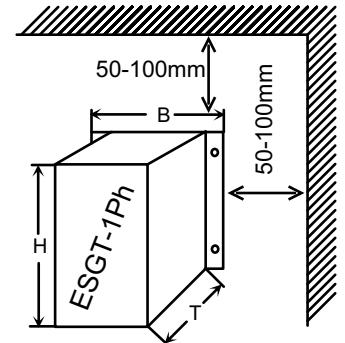

### Wiring the device:



Build mains connection (L1, N or L2) via fused circuit breakers with usual fuses.

The wiring for power supply and the wiring for control have to be laid in separate conduits or shield ducts.

It is essential to the electric installation to comply to the stipulations of the VDE (German Electrical Engineers Association), specifically to VDE 0100, VDE 0113, VDE 160.

## 5. EMC-equitable assembly

According to EMC standards thyristor controllers are regarded as components, which do not fulfil any intended use by themselves. The devices constitute a functional unit of the entire plant. The control electronics of the thyristor controllers are implemented according to valid EMC standards.

The builder of the plant has to supply the plant with appropriate mains chokes and mains filters. These components can also be obtained from us. Thyristor controllers with multicycle control usually do not require any additional mains filter circuit.

It should be noted that the standards of the resource category A are not sufficient in a special industrial sector, for example if sensitive measuring channels are affected. In this case, the user has to apply equipment of class B.

The class A is the usual class of equipments, which is normally intended for the use in the industrial sector. The devices are connected to the industrial network via an assigned transformer. Power controllers of class B are required if they should be used in the area of industry and small-scale industry and if they should be connected to the public low-voltage system.

### Use of mains chokes:

On the input side of the thyristor controllers, mains chokes reduce the current-dependent line reactions and effect an improvement of the performance factor. This reduces the current harmonics and improves the mains quality. The use of mains chokes is particularly recommended when connecting thyristor controllers with phase angle control to a grid-feeding point and when other electronic devices are attached to this network.

**Use of mains filters:**

Radio interference filters and mains filters (combination of radio interference filter and one mains choke) serve for protection against high-frequency disturbances, which are sent out via the power cable or the radiation of the power cable. The high-frequency disturbances should be limited to a mandatory or legal degree. Mains filters should possibly be mounted close to the thyristor controller and moreover it is necessary to ensure that the connecting cable between the thyristor controller and the mains filter is as short as possible.

**CAUTION:** The mounting surfaces of the thyristor controllers and the radio interference filters have to be free from paint and well conducting in the high-frequency range.

Furthermore, mains filters have leakage currents, which may become significantly larger than the nominal values in case of failure (phase failure, unbalanced load). To avoid dangerous voltages, the mains filters have to be grounded. As the leakage currents are high-frequent disturbances, the grounding measures have to be low-resistance and extensive.

With leakage currents, which exceed the value of 3,5mA, VDE 0160 or EN 60335 specify that either:

- the cross section of the protective conductor has to be  $\geq 10\text{mm}^2$ ,
- the protective conductor has to be monitored on interruption or
- a second protective conductor has to be laid.

**Shielding measures:**

Shielding measures help to reduce the radiated interference energy. Electrical lines between thyristor controller and load can be laid shielded. Thereby the shield must not replace the PE line. Four-wire cables (three phases + PE), whose shield is double-sided and extensive laid on earth potential (PES), are recommended. The shield must not be applied over the connecting wires. Interruptions of the shielding e.g. in the case of clamps, contactors, mains chokes etc. have to be bridged with low-resistance and appropriate space considerations.

In practice this can be done for example by interrupting the shield close to the assembly and then connecting it extensively with the earth potential (PES, shield clamp). The free cables, which are not shielded, should not be longer than 100mm.

**Grounding measures:**

Grounding measures are absolutely necessary to fulfil legal provisions. They constitute a prerequisite for an efficient use of further measures such as filters and shielding. All conductive, metallic housing components have to be electroconductive connected with the earth potential. For the EMC-measure, the important factor is not the cable's crosssection, but its surface, since this is where high frequency current flows to earth. Once again, all grounding points have to be led directly, extensively and with low-resistance to the central grounding point (equipotential bonding bar, star-shaped grounding system). The contact points have to be free from paint and corrosion (use galvanized mounting plate and materials).

## 6. Operation



To begin with, the electrical connections are to be done, according to the accompanying plans: L1, N or L2, T1, T2.

The thyristor controller have to be connected to the power supply according to the VDE rules, in a way that they can be disconnected again by appropriate switching means (i.e. master switch, contactor, protective power switch).

### Conducting wire installation:

The power supply, the user supply, as well as the control wiring have to be placed in separate ducts or conduits.

To avoid malfunction, it is advisable, to install the electronic signal wiring separated from the power supply and/or from the protective control wiring as well as to twist the feed and return signal lines or use shielded control lines (see also point 5. EMC-equitable assembly).

### Fuses:

The mains fuse protection depends on the recommended or employed power-transmission crossection and has to be carried out, according to DIN 57100, part 430/VDE 0100 and part 430/6.81.

The options /ES (electronic switch-off), /IB (electronic current limitation), /IS (symmetric current monitoring) and /IU (low current recognition) provide a malfunction report output with a simultaneous LED display.

The control electronics synchronously turn off the current of the power element.

### General information on the PTC-thermistor:

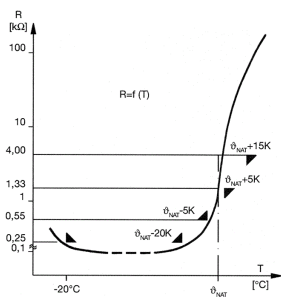

PTC-temperature sensors according to DIN 44081 (triplet design DIN 44082) are used to protect electrical machines against thermal overload. According to the present DIN standard they are arbitrarily exchangeable among themselves. It is a range of types from 60 to 190°C available.

PTC-temperature sensors with different rated shut-off temperatures can also be connected in series. Thereby it is possible to get optimum use out of machine Components and winding parts with different limit temperatures and to protect them cost-effectively.

### **Technical data PTC**

|   | Single      | Triplet     |            |
|---|-------------|-------------|------------|
| <b>Tolerance of <math>\vartheta_{NAT}</math></b>  | $\pm 5$     | $\pm 5$     | K          |
| <b>Reproducibility of <math>\vartheta_{NAT}</math></b>                                      | $\pm 0,5$   | $\pm 0,5$   | K          |
| <b>Cold resistance <math>R_{25}</math></b>  | $\leq 100$  | $\leq 300$  | $\Omega$   |
| <b>Cold resistance at a cold-conductor temperature of <math>\vartheta_{NAT} -5K</math></b>  | $\leq 550$  | $\leq 1650$ | $\Omega$   |
| <b>Cold resistance at a cold-conductor temperature of <math>\vartheta_{NAT} +5K</math></b>  | $\geq 1330$ | $\geq 3990$ | $\Omega$   |
| <b>Cold resistance at a cold-conductor temperature of <math>\vartheta_{NAT} +15K</math></b> | $\geq 4$    | $\geq 12$   | k $\Omega$ |
| <b>Thermal response time <math>t_a</math></b>   | $\leq 5$    | $\leq 5$    | s          |

## 7. Meaning of the clamp connections

### Clamp connections on the function panel:

These connections can be found on the function module and obey the following numbering scheme.

| <b>Activation:</b> |  |
|--------------------|--|
| 1, 2               | activated: closed<br>standby: open                   |
| 3, 4               | nominal control signal 0...10V, 0...20mA or 4...20mA |

| <b>Special functions:</b> |  |
|---------------------------|--|
| 5, 6                      | blocking the power element: open<br>(The red LED will be illuminated if clamps 5 - 6 are open) |
| 5, 6                      | in operation: closed   |

### Clamps on the control and monitoring print:

|            |  |
|------------|--|
| L1, N      | Connection of 230V AC<br>(Option: Any control voltages can be realised at customer wish )  |
| 14, 15, 16 | output switch terminal S1<br>Contact positions see time diagram on the page 8  |
| 17, 18, 19 | output switch terminal S2<br>Contact positions see time diagram on the page 8  |
| 20, 21, 22 | malfunction report output switch terminal<br>Contact positions:<br><ul style="list-style-type: none"> <li>• without auxiliary voltage in normal operation: 21 - 22 closed</li> <li>• with auxiliary voltage in norma operation: 21 - 22 closed</li> <li>• without auxiliary voltage at the fault: 21 - 22 closed</li> <li>• with auxiliary voltage at the fault: 21 - 20 closed</li> </ul> |
| 23, 24     | auxiliary input, i.e. for PTC-sensor according to DIN 44081 or other applications<br><ul style="list-style-type: none"> <li>• 23 - 24 open = lock</li> <li>• 23 - 24 closed = in operation</li> </ul>  |
| 7          | voltage supply for potentiometer control<br>(can be found on the analogous module)   |

## 8. Technical features of the control and monitoring panel

The control panel of the thyristor controller provides various control and protection functions. This panel is supplied with 230V AC by the clamps L1 and N to generate an internal direct voltage of 15V DC. The control panel also consists of an interchangeable function panel (100x75mm) which determines the function mode of the device.

### Explanation of the LEDs on the control and function panel

|                   |   |
|-------------------|---|
| <b>LED 1 (rd)</b> | <b>Meaning:</b> Temperature exceed of cooling or power element<br><b>Reason:</b> Overload, to high current, to high switching frequency.<br>The threshold value of turning off is at 75° C. |
| <b>LED 2 (rd)</b> | <b>Meaning:</b> Phase failure<br><b>Reason:</b> One or more phases are not connected with the mains connections L1, L2, L3 (Check the contacts!)  |
| <b>LED 3 (rd)</b> | <b>Meaning:</b> Temperature exceed of the load (PTC)<br><b>Reason:</b> PTC has triggered or open bridge 23 - 24   |
| <b>LED 4 (gn)</b> | <b>Meaning:</b> Auxiliary voltage connected (device in operation)   |

If there is none of the explained malfunctions, all red LEDs have to go out by activating the device (e.g. by connecting the contacts 1 - 2 / reset procedure).

|                 |  |
|-----------------|--|
| <b>LED "SE"</b> | Activation   |
| <b>LED "S1"</b> | switching facility S1 actuated<br>(contacts S1 and LED S1 are activated synchronously) |
| <b>LED "S2"</b> | switching facility S2 actuated   |

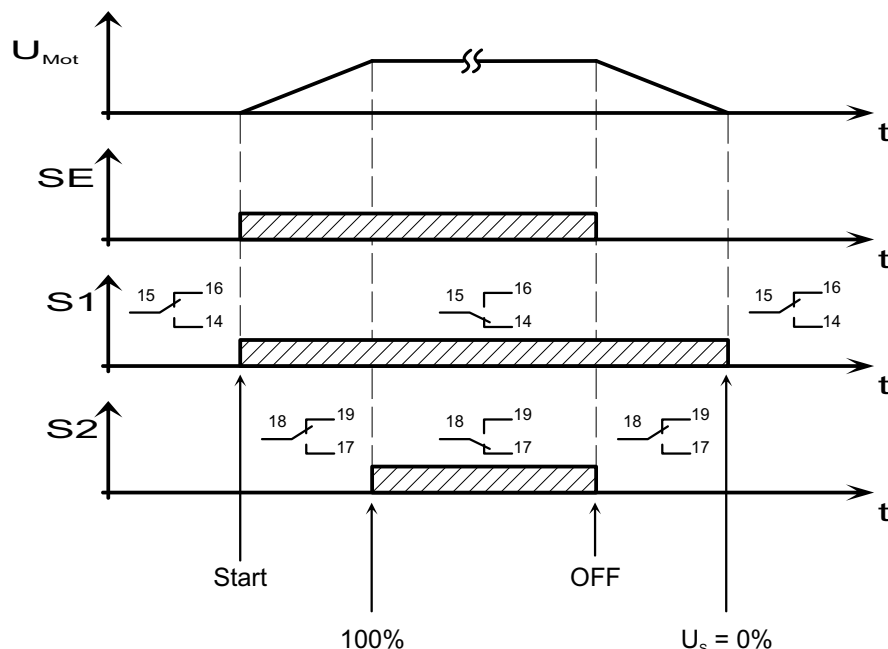

The switch positions show the clamp contacts from 14 to 19 at the control panel.



## 9. Basic circuit

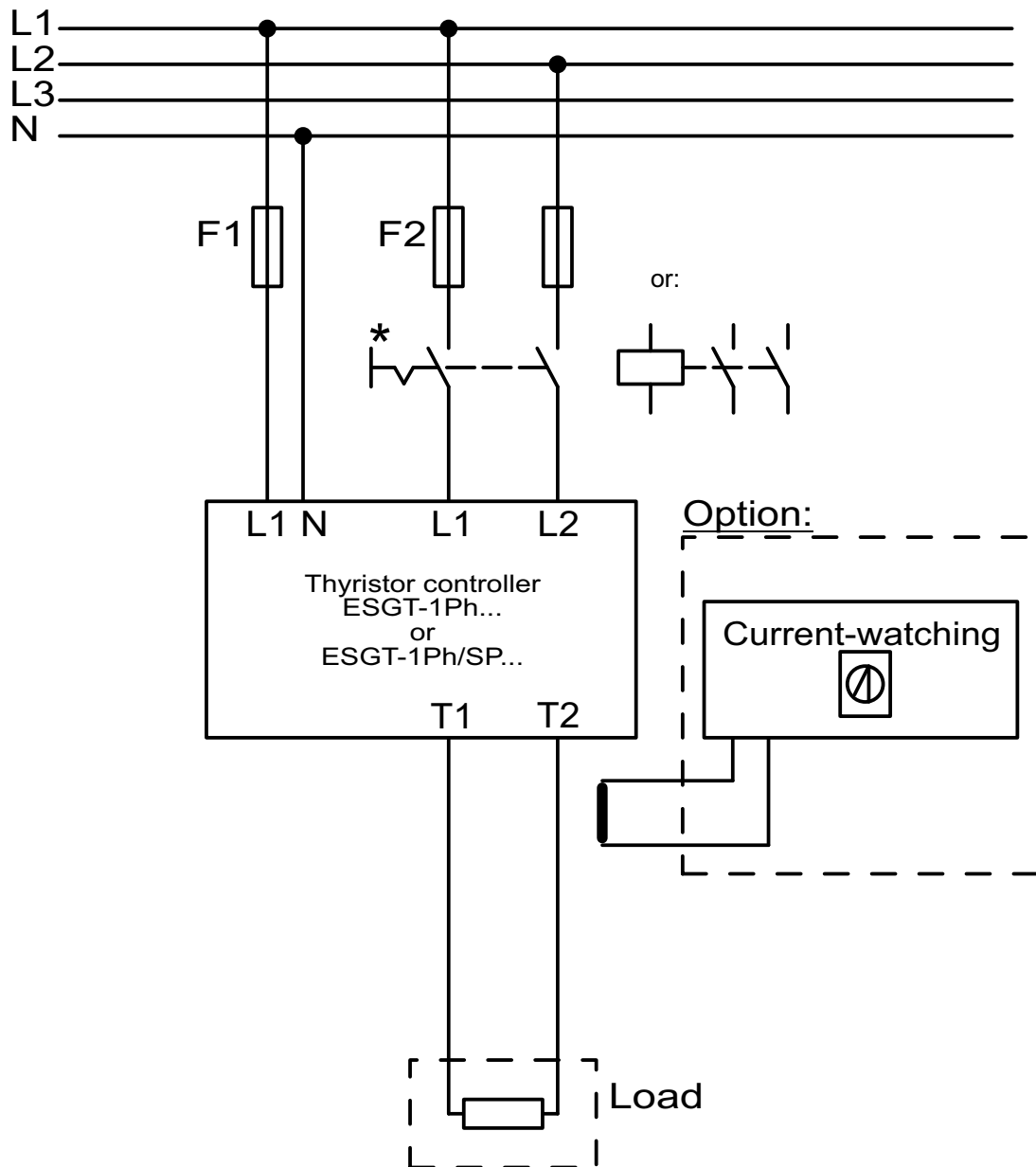

Note: The option constant current controlling (/I) or current limitation (/IB) is sensibly applicable only for devices with firing mode, because here a continuous measurement of the load current makes sense.

\* For isolate you can plug connection, fuses, circuit-breakers, load-breakers and residual current devices (RCDs). Contactor, however, can be used only in exceptional cases and due to isolate.

## 10. Control and monitoring print

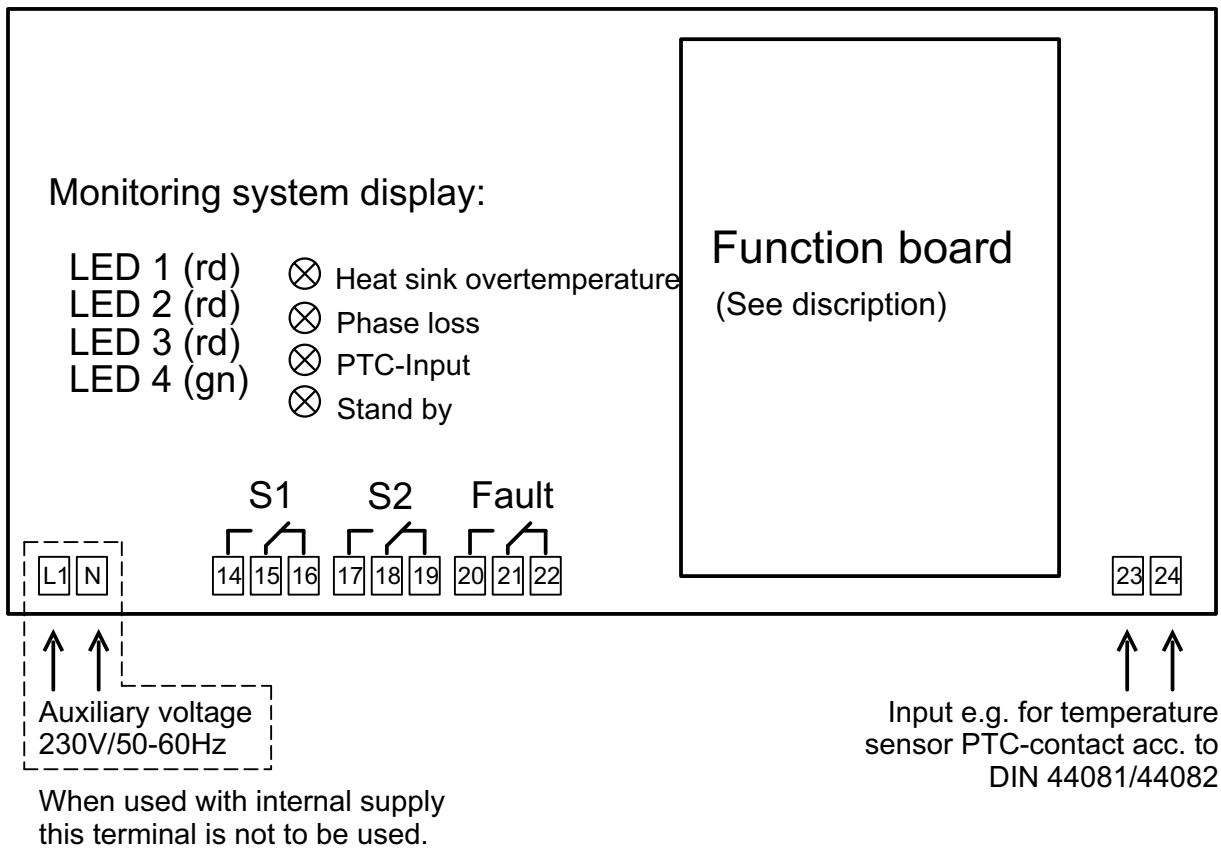

### Explanation of the LED indicators

|   |  |
|---|--|
| <b>LED 1</b>  | temperature exceedance of the cooling element          |
| <b>LED 2</b>  | phase failure  |
| <b>LED 3</b>  | temperature exceedance of the load or other components |
| If there is one of the explained malfunctions, it will be saved and the malfunction indication will be activated. (clamps 20-21-22) |  |
| <b>LED 4</b>  | auxiliary voltage is on                                |

### Auxiliary contacts S1 and S2

Exchangeable alternating contacts (5A/230V), activated by the following switching position:

|                      |  |
|----------------------|--|
| <b>U<sub>L</sub></b> | output voltage of the thyristor controller at T1, T2 |
| <b>S1</b>            | switching position at "output voltage" on            |
| <b>S2</b>            | 100% output voltage reached                          |

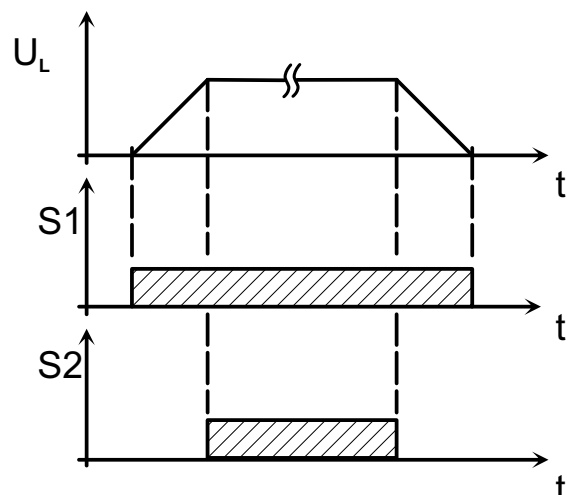

# 11. Control unit

## 11.1 Analogous module

Controlling of thyristor controllers by analogous signals

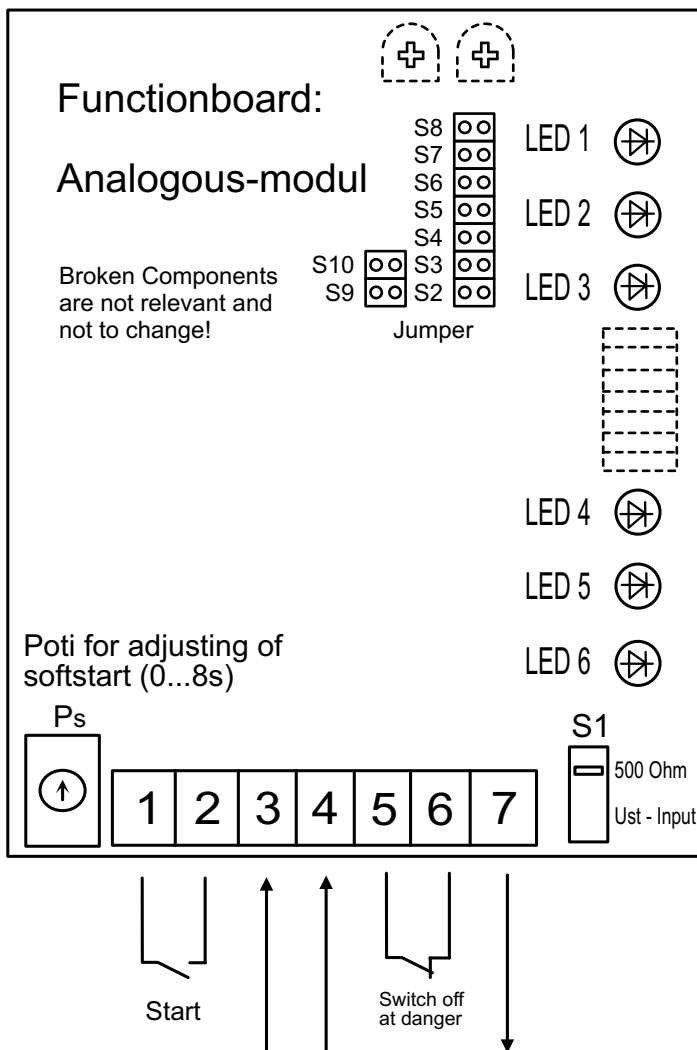

### Meaning of LEDs:







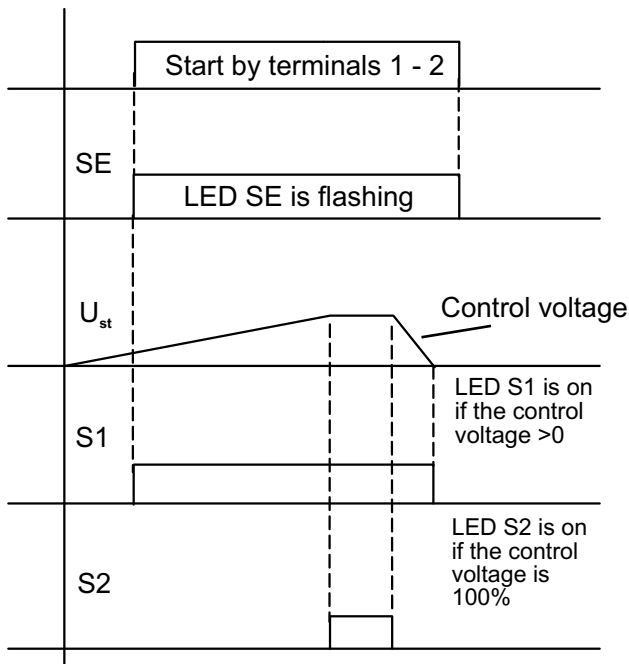
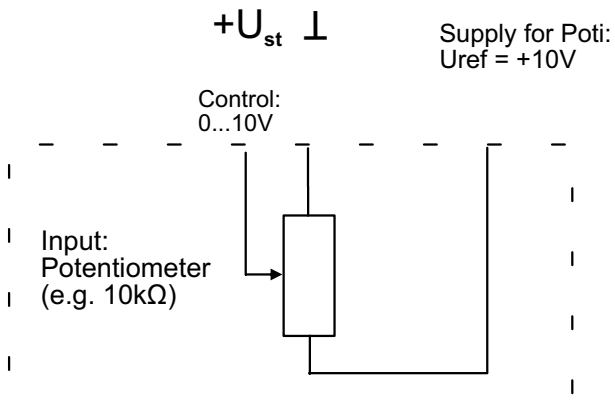















































- LED 1:**  
The light intensity of the display is dependent on the height of the control (no meaning for devices with multicycle control);
- LED 2:**  
Flashes, when multicycle control is active, is dependent of the control 1Hz (no meaning for devices with phase control);
- LED 3:**  
An open contact 5/6 the LED 3 lights up. Likewise, this LED shows faults on the control panel;
- LED 4:**  
Input: SE (LED 4)  
Lights up Activation;
- LED 5:**  
Output: S1 (LED 5)  
Lights up, when control signal >0;
- LED 6:**  
Output: S2 (LED 6)  
Lights up, when 100% output voltage is reached;

### Switch S1 (500 Ohm):

- Current control (e.g.: for 0...20mA);
- Voltage control  $R_i > 50k$  (e.g.: for 0...10V);



## 11.2 Settings for the various controls

|   | Phase angle control   | Mutlicycle control   |
|---|---|--|
| <b>Control:<br/>0...10V</b>   | Switch S1: OFF  | Switch S1: OFF   |
|   | Jumper S2 closed     | Jumper S2 open      |
|   | Jumper S3 open       | Jumper S3 open      |
|   | Jumper S4 closed     | Jumper S4 closed    |
|   | Jumper S5 closed     | Jumper S5 open      |
|   | Jumper S6 open       | Jumper S6 open      |
|   | Jumper S7 open       | Jumper S7 closed    |
|   | Jumper S8 closed     | Jumper S8 open      |
|   | Jumper S9 open       | Jumper S9 open      |
|   | Jumper S10 offen     | Jumper S10 open     |
| <b>Control:<br/>0...20mA</b>  | Switch S1: ON   | Switch S1: ON  |
|   | Jumper S2 closed     | Jumper S2 open      |
|   | Jumper S3 open       | Jumper S3 open      |
|   | Jumper S4 closed     | Jumper S4 closed    |
|   | Jumper S5 closed     | Jumper S5 open      |
|   | Jumper S6 open      | Jumper S6 open     |
|   | Jumper S7 open     | Jumper S7 closed  |
|   | Jumper S8 closed   | Jumper S8 open    |
|   | Jumper S9 open     | Jumper S9 open    |
|   | Jumper S10 open    | Jumper S10 open   |
| <b>Control:<br/>4...20mA</b>  | Switch S1: ON   | Switch S1: ON  |
|   | Jumper S2 closed   | Jumper S2 open    |
|   | Jumper S3 closed   | Jumper S3 closed  |
|   | Jumper S4 open     | Jumper S4 open    |
|   | Jumper S5 closed   | Jumper S5 open    |
|   | Jumper S6 open     | Jumper S6 open    |
|   | Jumper S7 open     | Jumper S7 closed  |
|   | Jumper S8 closed   | Jumper S8 open    |
|   | Jumper S9 open     | Jumper S9 open    |
| Jumper S10 open  | Jumper S10 open  |  |

## 12. Survey of the individual types

| Type*         | max. load current | rec. semi-conductor fuses | Mains fuse | rec. cross-section | max. power** | Power loss at nominal rating | Weight | Frame size | Dimensions WxHxD |
|---------------|-------------------|---------------------------|------------|--------------------|--------------|------------------------------|--------|------------|------------------|
|               | [A]               | [A]                       | [A]        | [mm <sup>2</sup> ] | [kW]         | [W]                          | [kg]   |            | [mm]             |
| ESGT-1Ph 05   | 5                 | 10                        | 16         | 1,5                | 2,0          | 4                            | 1,0    | A          | 200x140x115      |
| ESGT-1Ph 08   | 8                 | 15                        | 16         | 1,5                | 3,2          | 7                            | 1,1    | A          | 200x140x115      |
| ESGT-1Ph 15   | 15                | 25                        | 25         | 2,5                | 6,0          | 13                           | 1,4    | A          | 200x140x115      |
| ESGT-1Ph 25   | 25                | 30                        | 25         | 4,0                | 10,0         | 22                           | 1,5    | A          | 200x140x115      |
| ESGT-1Ph 35   | 35                | 40                        | 35         | 6,0                | 14,0         | 31                           | 1,6    | A          | 200x140x115      |
| ESGT-1Ph 50   | 50                | 60                        | 50         | 10                 | 20,0         | 45                           | 2,8    | B          | 260x205x170      |
| ESGT-1Ph 60   | 60                | 80                        | 80         | 16                 | 24,0         | 54                           | 2,8    | B          | 260x205x170      |
| ESGT-1Ph 75   | 75                | 80                        | 80         | 16                 | 30,0         | 67                           | 3,0    | B          | 260x205x170      |
| ESGT-1Ph 90   | 90                | 100                       | 100        | 25                 | 36,0         | 81                           | 3,0    | B          | 260x205x170      |
| ESGT-1Ph 120  | 120               | 130                       | 125        | 35                 | 48,0         | 108                          | 3,0    | B          | 260x205x170      |
| ESGT-1Ph 160  | 160               | 200                       | 160        | 50                 | 64,0         | 144                          | 4,0    | B          | 260x205x170      |
| ESGT-1Ph 220  | 220               | 300                       | 250        | 70                 | 88,0         | 198                          | 7,8    | C          | 360x250x200      |
| ESGT-1Ph 280  | 280               | 400                       | 315        | 95                 | 112,0        | 252                          | 8,8    | C          | 360x250x200      |
| ESGT-1Ph 350  | 350               | 450                       | 355        | 120                | 140,0        | 315                          | 9,4    | C          | 360x250x200      |
| ESGT-1Ph 420  | 420               | 450                       | 400        | 150                | 168,0        | 378                          | 9,4    | C          | 360x250x200      |
| ESGT-1Ph 560  | 560               | 750                       | 630        | 240                | 224,0        | 504                          | 9,4    | C          | 360x250x200      |
| ESGT-1Ph 720  | 720               | 900                       | 800        | 300                | 288,0        | 648                          | 12,0   | D          | 360x445x210      |
| ESGT-1Ph 1000 | 1000              | 1200                      | 1000       | 500                | 400,0        | 900                          | 12,0   | D          | 415x525x210      |
| ESGT-1Ph 1250 | 1250              | 1800                      | 1250       | 630                | 500,0        | 1125                         | 13,5   | D          | 415x525x210      |
| ESGT-1Ph 1400 | 1400              | 1800                      | 1500       | 2x400              | 560,0        | 1260                         | 13,5   | D          | 415x525x210      |
| ESGT-1Ph 1600 | 1600              | 2000                      | 1600       | 2x400              | 640,0        | 1440                         | 18,5   | E          | 600x540x346      |
| ESGT-1Ph 1850 | 1850              | 2x1000                    | 1800       | 2x500              | 740,0        | 1665                         | 18,5   | E          | 600x540x346      |
| ESGT-1Ph 2100 | 2100              | 2x1250                    | 2000       | 2x630              | 800,0        | 1800                         | 24,0   | E          | 600x540x346      |
| ESGT-1Ph 2500 | 2500              | 2x1250                    | 2500       | 2x630              | 1000,0       | 2250                         | 24,0   | E          | 600x540x346      |

Errors and technical modifications excepted (Date: 2015/12)

Recommendations of the cross sections according to VDE 0298-4 (August 2003), table 4, laying system E and F

\* The given details also apply to the version with multicycle control ESGT-1Ph/SP...

\*\* The given values for the max. power applies to operation at 3x 400V.

The given values refer to the operation voltage of 3x400V AC.

The values given for overload refer to a surrounding temperature exceed of max. 55°C and an installation altitude of 1000m. (VDE 0298 part 4, August 2003).

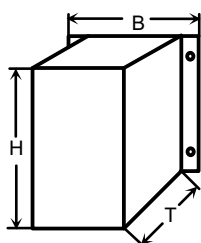

### 13. Technical data

|                              |  |
|------------------------------|--|
| Power supply                 | 230V AC / 50-60Hz standard<br>(optional: 24V DC, 400V AC internal)   |
| Mains voltage                | 1-phase 110V...400V AC ( $\pm 10\%$ )<br>(optional: 500V, 690V, 1000V)   |
| Max. Bemessungsstrom         | siehe Tabelle unter 12. (5 – 2500A)  |
| Max. current load            | cf. table "12. Survey of the individual types" (5 – 2500A)   |
| Mains frequency              | 48Hz...62Hz  |
| Phase sequence               | self synchronizing   |
| Types of the load            | ohmic and inductive load   |
| Kind of protection           | IP 23  |
| Moisture class               | E according to DIN 40040   |
| Built in device              | VDE 0160 5.5.1.3 / DIN EN 50178  |
| potential separation         | according to VDE 0160 5,6  |
| Installation                 | vertical, electrical connections downside  |
| Indication of operation mode | LEDs (SE, S1, S2)  |
| Ambient temperature          | 0...+55°C  |
| Current limiting             | 5...100% of the $I_n$  |
| Malfunction indication       | phase failure, temperature exceedance of the cooling element, lack of voltage, thyristor fault   |
| CE-regulations               | EMC Directive 2014/30/EU<br>LVD 2014/35/EU   |
| Control signals (standard)   | <ul style="list-style-type: none"> <li>• 0...10V DC</li> <li>• 0...20mA DC</li> <li>• 4...20mA DC</li> <li>• potentiometer input (5k<math>\Omega</math>...25k<math>\Omega</math>): 0...10V DC</li> </ul> |
| optional                     | <ul style="list-style-type: none"> <li>• 0...5V DC</li> <li>• 0...10mA DC</li> <li>• 0...5mA DC</li> <li>• 10...0V DC (inverse)</li> <li>• 20...4mA (inverse)</li> <li>• 20...0mA (inverse)</li> </ul>   |

Errors and technical modifications excepted (Date: 2016/11)

#### Options

- constant current controlling (/I)
- constant voltage controlling (/U)
- current limitation (/IB)
- current output 0...10V (/AI)
- voltage output 0...10V (/AU)
- modified auxiliary voltage 24V DC (/24VDC)
- modified auxiliary voltage 400V AC (/400V)
- internal auxiliary voltage (/IV)
- mains voltage: 500V AC (/500V)
- mains voltage: 690V AC (/690V)
- mains voltage: 1000V AC (/1000V)
- electronic switch-off (/ES)
- symmetric current monitoring (/IS)
- low current recognition (/IU)
- load limiting:  $U \times I$  – Regulation (/UxI)
- power controlling:  $P = f(U, I)$  (/P)
- voltage feedback:  $U^2$  (/U<sup>2</sup>)
- current feedback:  $I^2$  (/I<sup>2</sup>)
- power controlling:  $P = f(1/RL)$  (/RL)
- interface: Profibus (/Prof)
- interface: Modbus (/Mod)
- interface: Canbus (/Can)
- interface: RS 232 (/RS-232)
- interface: RS 485 (/RS-485)
- kind of protection: IP 55 (/IP55)
- kind of protection: IP 65 (/IP65)

## 14. Frame sizes

### Frame size: A

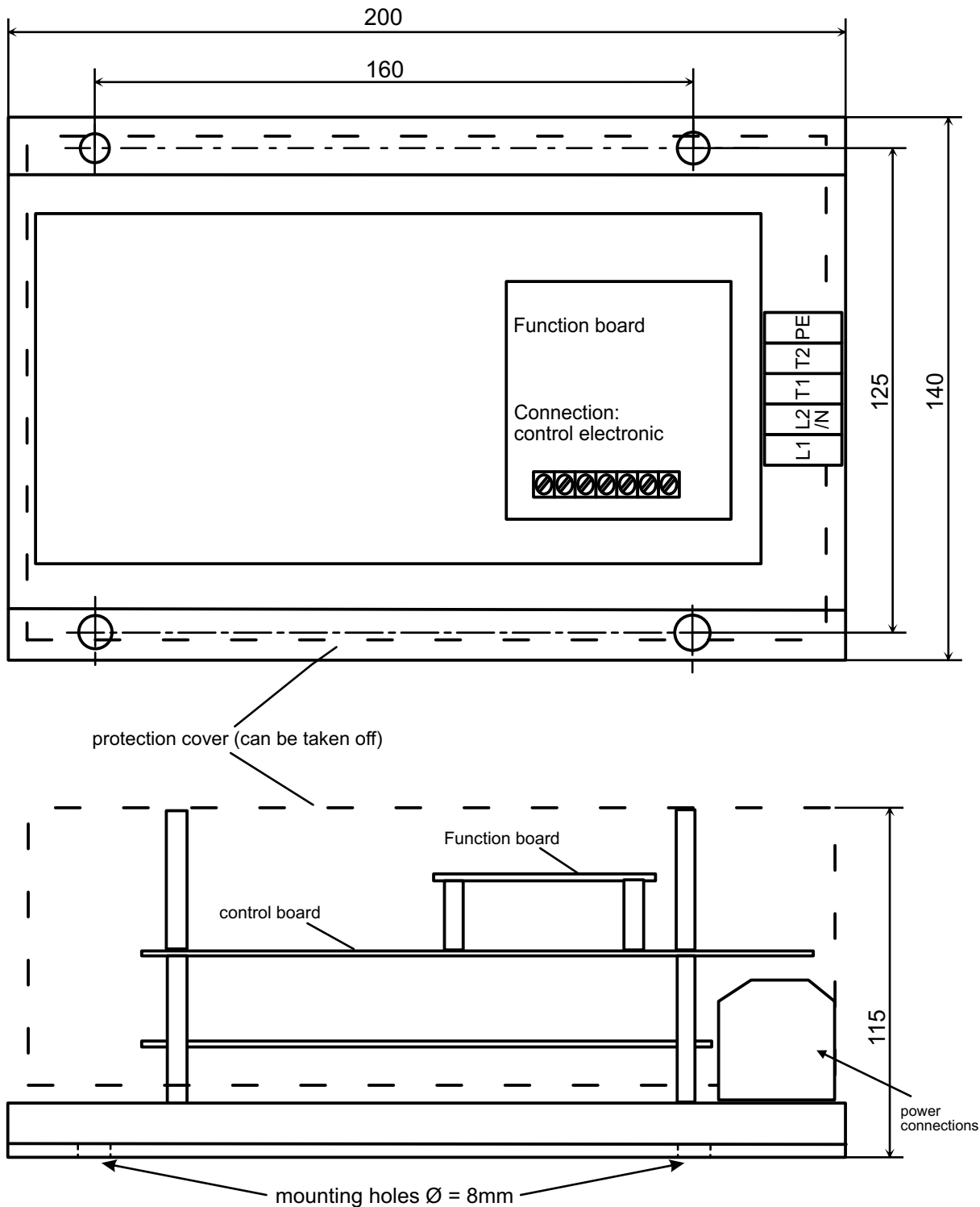

Power connections (L1...T2): according to version  
(ESGT-1Ph 05, 08, 15, 25, 35, frame size A)

Due to ongoing technical development and modifications we reserve the Right to deliver products which might be slightly different from those Described above.

|         |                         |        |   |
|---------|-------------------------|--------|---|
|         | date                    | name   |  Elektroniksysteme GmbH<br>Eichelreuth 13<br>D-83224 Grassau<br>Tel.: 08641/598360<br>Fax.: 08641/598364 |
| worked: | 2008/08/05              | F. St. |   |
|         |                         |        | Thyristor controller<br>ESGT-1Ph...<br>frame size A   |
| date:   | bemaßung-baugröße-A.des |        |   |

**Frame size: B**

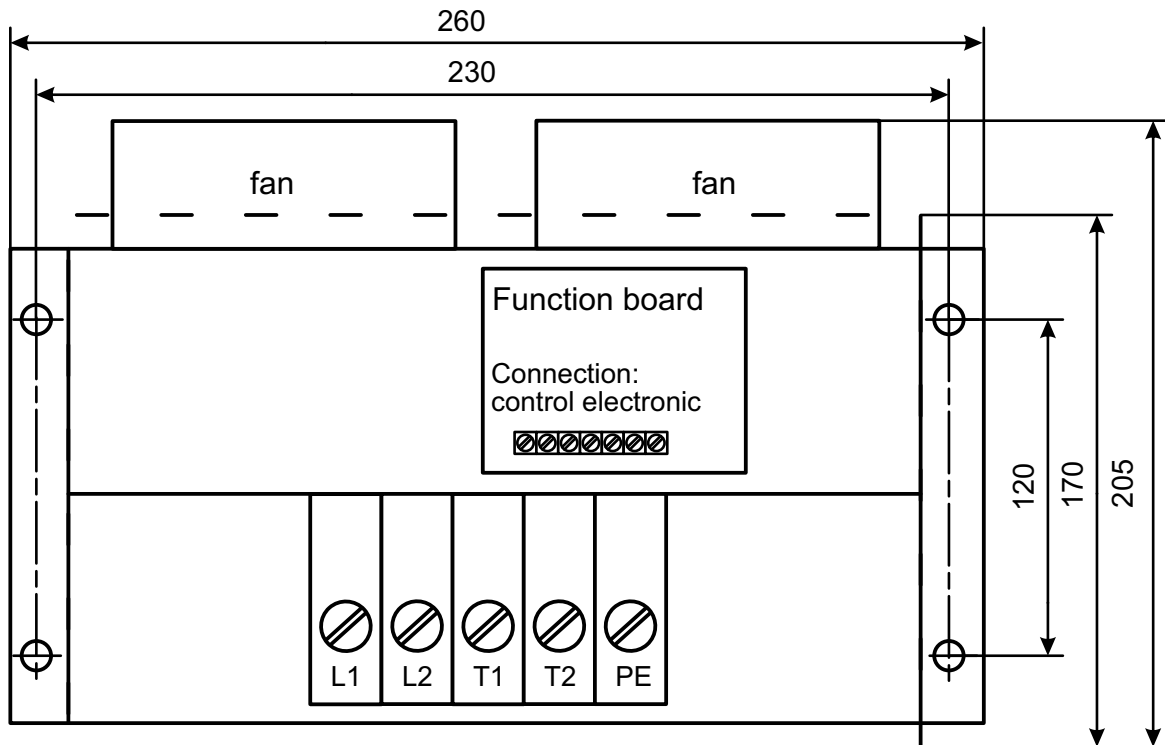

protection cover (can be taken off)

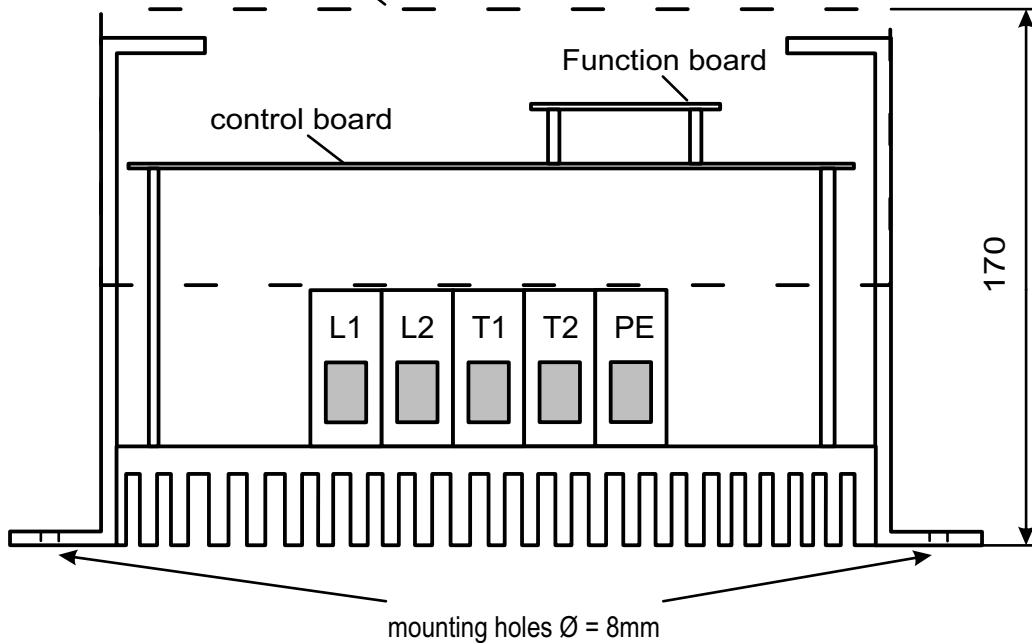

Power connections (L1...T2): 1,5 to 6mm<sup>2</sup>  
(ESGT-1Ph 50, 60, 75, 90, 120, 160, frame size B)

|         |                         |        |   |
|---------|-------------------------|--------|---|
|         | date                    | name   |  Elektroniksysteme GmbH<br>Eichelreuth 13<br>D-83224 Grassau<br>Tel.: 08641/598360<br>Fax.: 08641/598364 |
| worked: | 30.06.2008              | F. St. |   |
|         |                         |        |   |
|         |                         |        |   |
| date:   | bemaßung-baugröße-B.des |        | Thyristor controller<br>ESGT-1Ph...<br>frame size B   |

Due to ongoing technical development and modifications we reserve the Right to deliver products which might be slightly different from those Described above.



**Frame size: C**

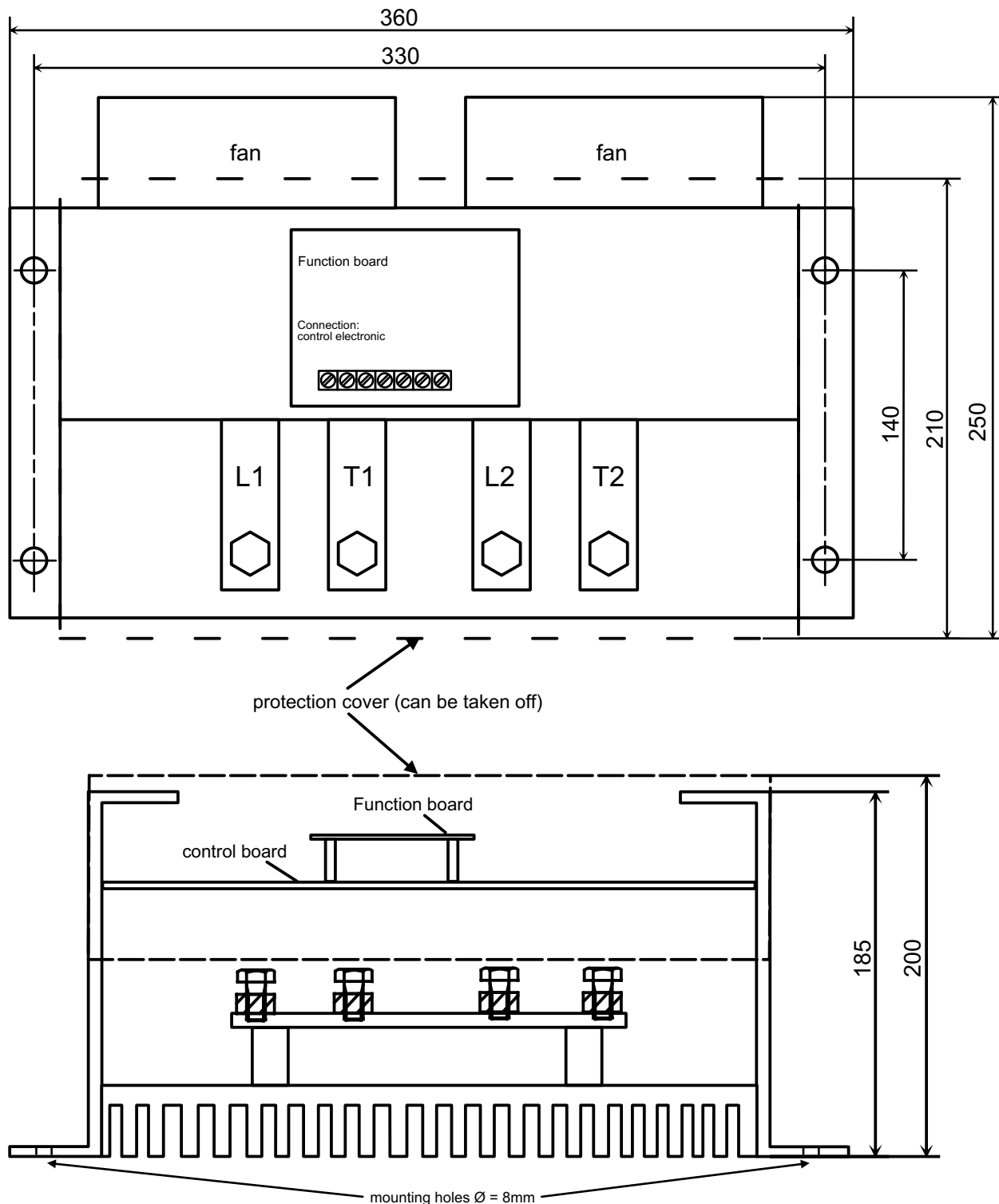

Power connections (L1...T2): M8  
(ESGT-1Ph 220, 280, 350, 420, 560, frame size C)

|         |                         |        |   |
|---------|-------------------------|--------|---|
|         | date                    | name   |  Elektroniksysteme GmbH<br>Eichelreuth 13<br>D-83224 Grassau<br>Tel.: 08641/598360<br>Fax.: 08641/598364 |
| worked: | 2015/12/08              | F. St. |   |
|         |                         |        | Thyristor controller<br>ESGT-1Ph...<br>frame size C   |
| date:   | bemaßung-baugröße-C.des |        |   |

Due to ongoing technical development and modifications we reserve the Right to deliver products which might be slightly different from those Described above.

**Frame size: D**

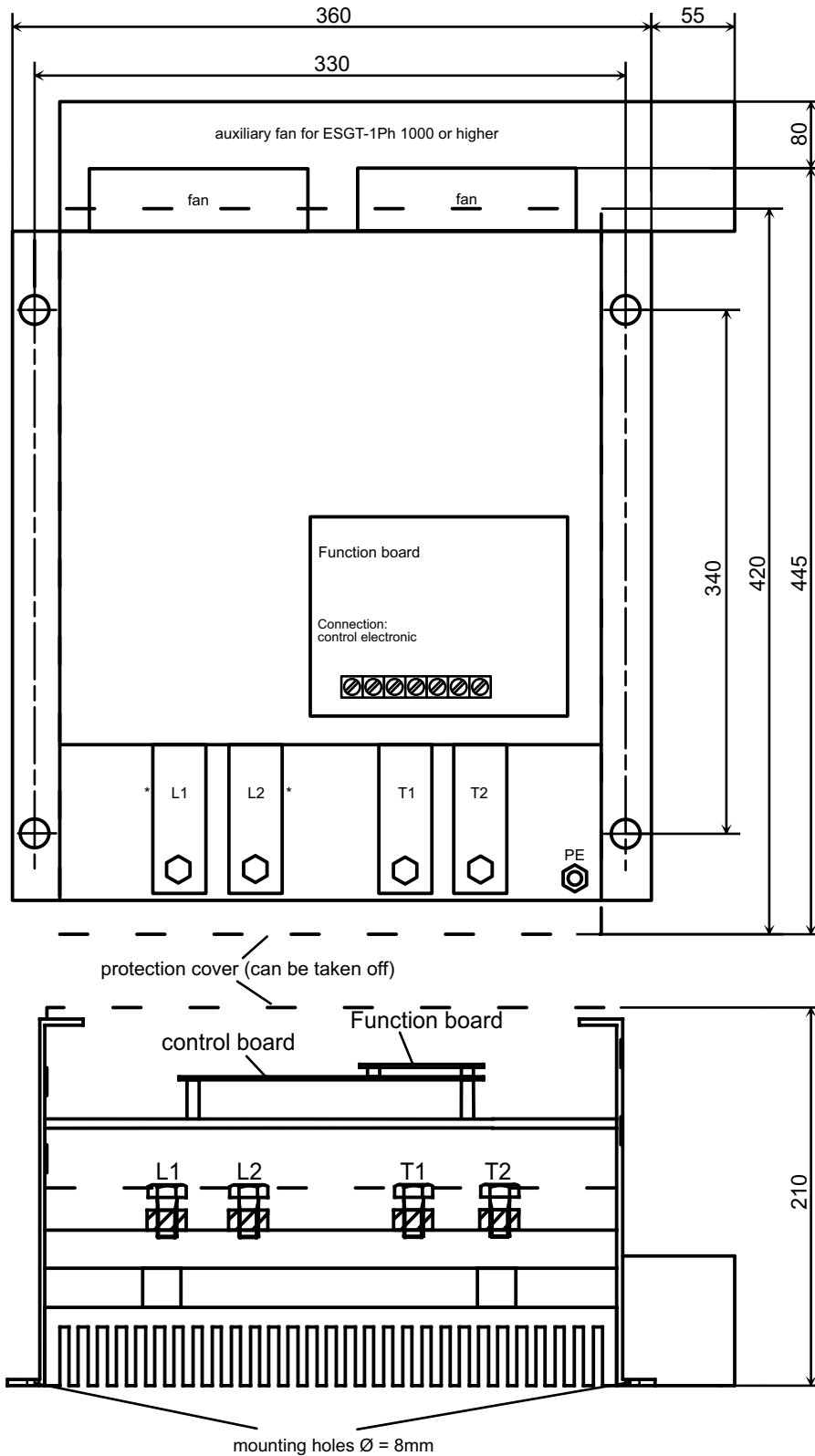

Power connections (L1...T2): M8  
 \*Semiconductor fuses are available as an option  
 (ESGT-1Ph 720, 1000, 1250, 1400, frame size D)

Due to ongoing technical development and modifications we reserve the Right to deliver products which might be slightly different from those Described above.

|         |                         |             |   |
|---------|-------------------------|-------------|---|
|         | date                    | name        |  Elektroniksysteme GmbH<br>Eichelreuth 13<br>D-83224 Grassau<br>Tel.: 08641/598360<br>Fax.: 08641/598364 |
| worked: | 2015/12/08              | F. St. / KS |   |
|         |                         |             |   |
|         |                         |             |   |
| date:   | bemaßung-baugröße-D.des |             | Thyristor controller<br>ESGT-1Ph...<br>frame size D   |

**Frame size: E**

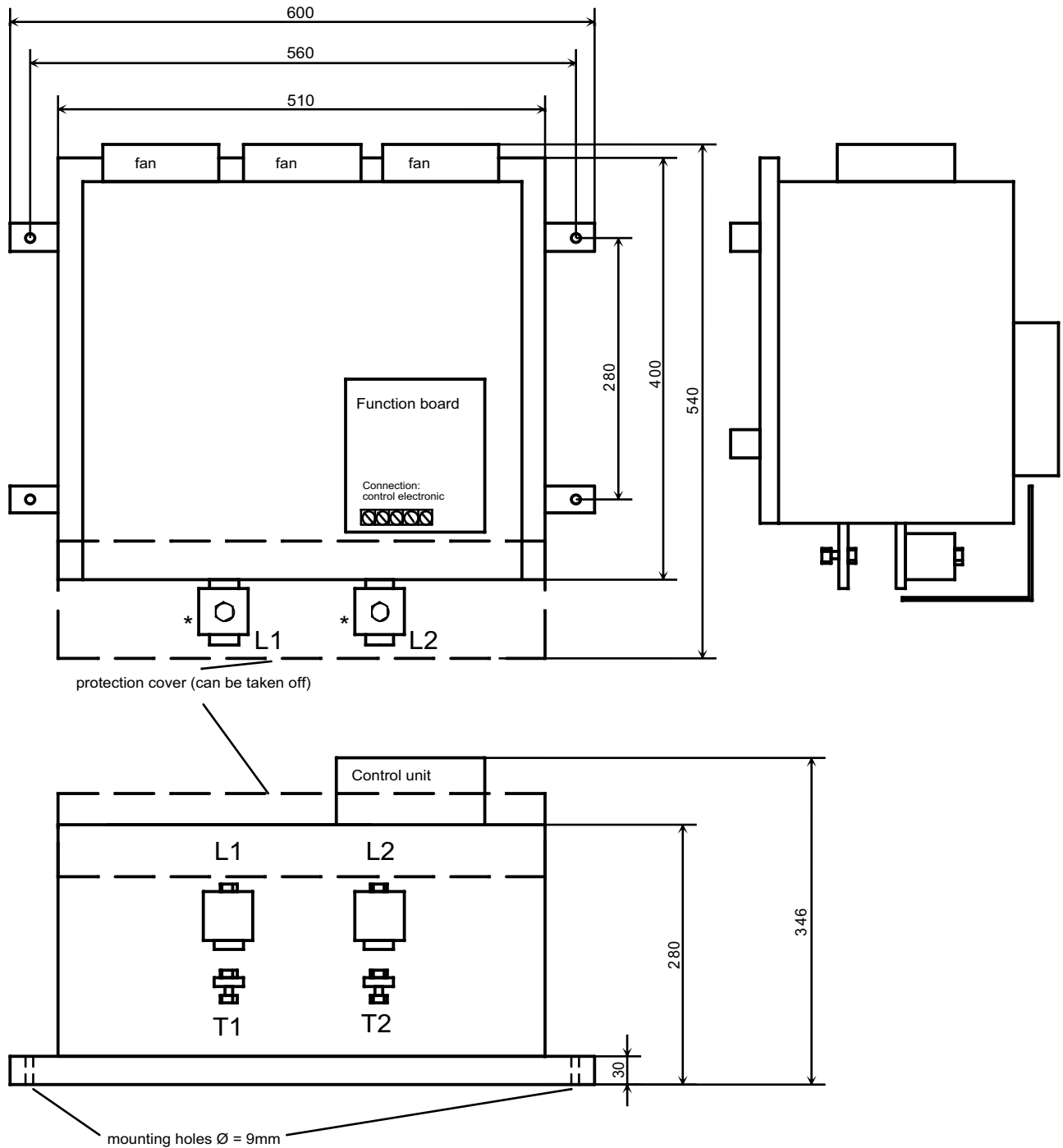

Power connections (L1...T2): M10 / M8  
 \*Semiconductor fuses are available as an option  
 (ESGT-1Ph 1600, 1850, 2100, 2500, frame size E)

Due to ongoing technical development and modifications we reserve the Right to deliver products which might be slightly different from those Described above.

|         |                         |        |   |
|---------|-------------------------|--------|---|
|         | date                    | name   |  Elektroniksysteme GmbH<br>Eichelreuth 13<br>D-83224 Grassau<br>Tel.: 08641/598360<br>Fax.: 08641/598364 |
| worked: | 2008/08/05              | F. St. |   |
|         |                         |        |   |
| date:   | bemaßung-baugröße-E.des |        | Thyristor controller<br>ESGT-1Ph...<br>frame size E   |